

Model	Size [mm]	A [mm]	B [mm]	C [mm]	A+XKC00PX02	A+KTS_X22X
KTSUX42P + KTS_X00X	800x2000	775-800	255-280	520	820-860	800-830
KTSUX41P + KTS_X00X	900x2000	875-900	355-380	520	920-960	900-930
KTSUX43P + KTS_X00X	1000x2000	975-1000	405-430	570	1020-1060	1000-1030
KTSUX44P + KTS_X00X	1100x2000	1075-1100	455-480	620	1120-1160	1100-1130
KTSUX45P + KTS_X00X	1200x2000	1175-1200	505-530	670	1220-1260	1200-1230

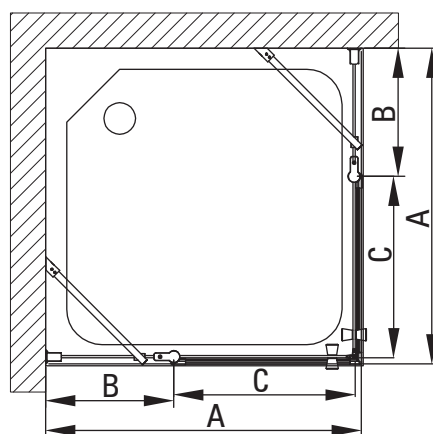

Model	Size [mm]	A [mm]	B [mm]	C [mm]
KTSUX42P	800x2000	787-800	255-268	515
KTSUX41P	900x2000	887-900	355-368	515
KTSUX43P	1000x2000	987-1000	405-418	565
KTSUX44P	1100x2000	1087-1100	455-468	615
KTSUX45P	1200x2000	1187-1200	505-518	665

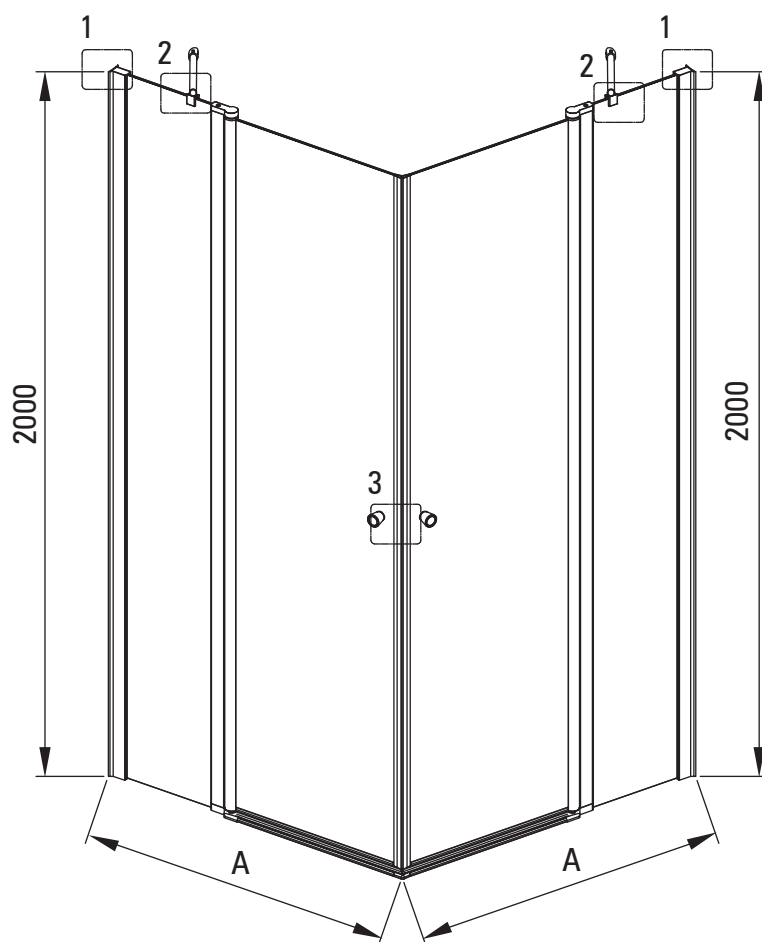
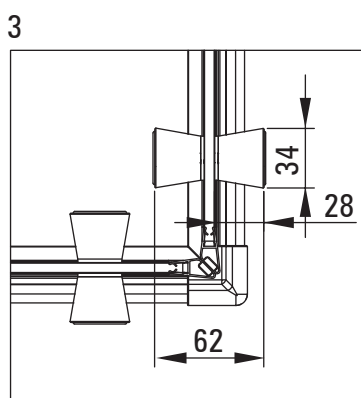
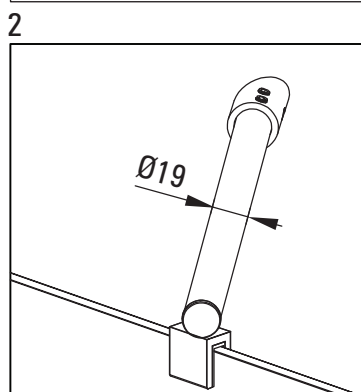
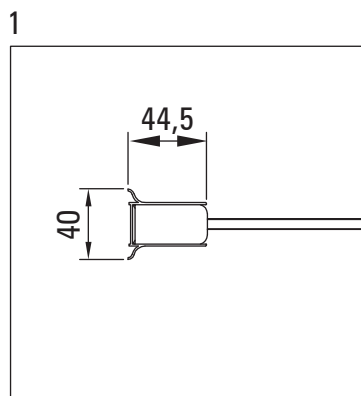
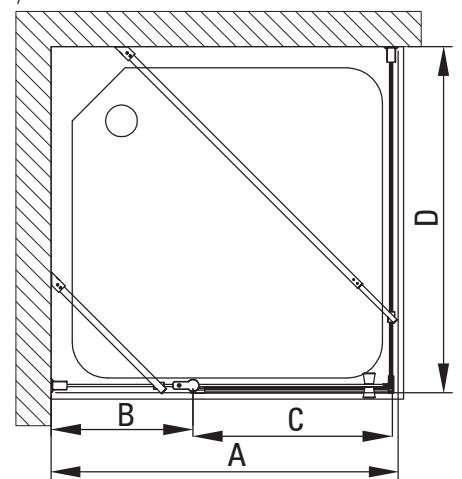
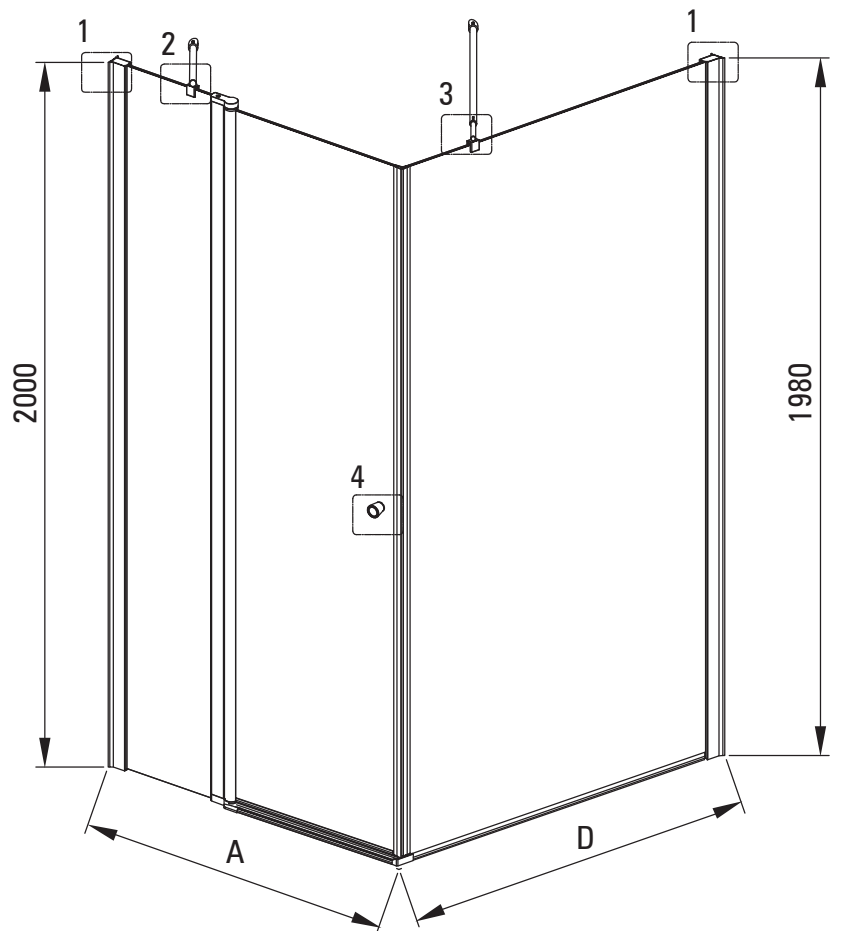
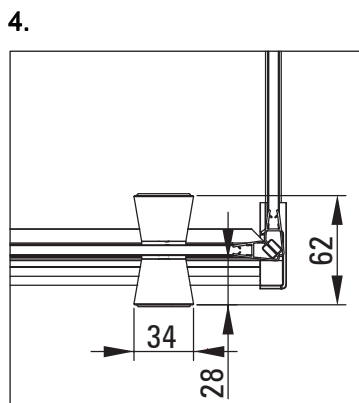
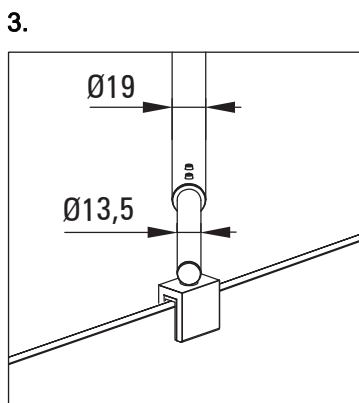
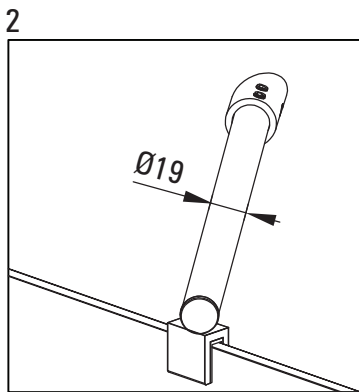
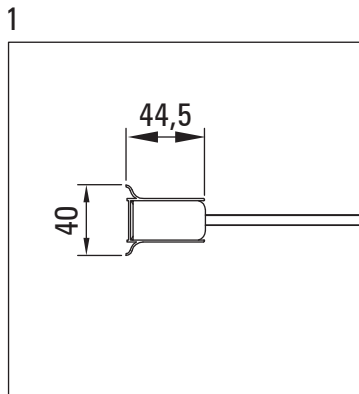

Model	Size [mm]	A [mm]	B [mm]	C [mm]
KTSUX42P	800x2000	787-800	255-268	515
KTSUX41P	900x2000	887-900	355-368	515
KTSUX43P	1000x2000	987-1000	405-418	565
KTSUX44P	1100x2000	1087-1100	455-468	615
KTSUX45P	1200x2000	1187-1200	505-518	665

Model	D [mm]
KTS_X83P	280-300
KTS_X84P	380-400
KTS_X85P	480-500
KTS_X86P	580-600
KTS_X37P	680-700
KTS_X38P	780-800
KTS_X39P	880-900
KTS_X30P	980-1000
KTS_X31P	1080-1100
KTS_X32P	1180-1200
KTS_X34P	1380-1400

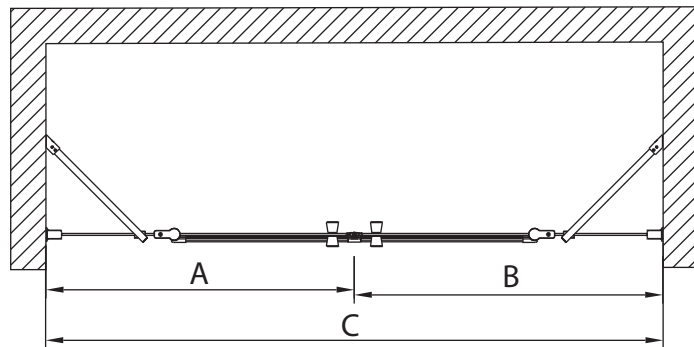
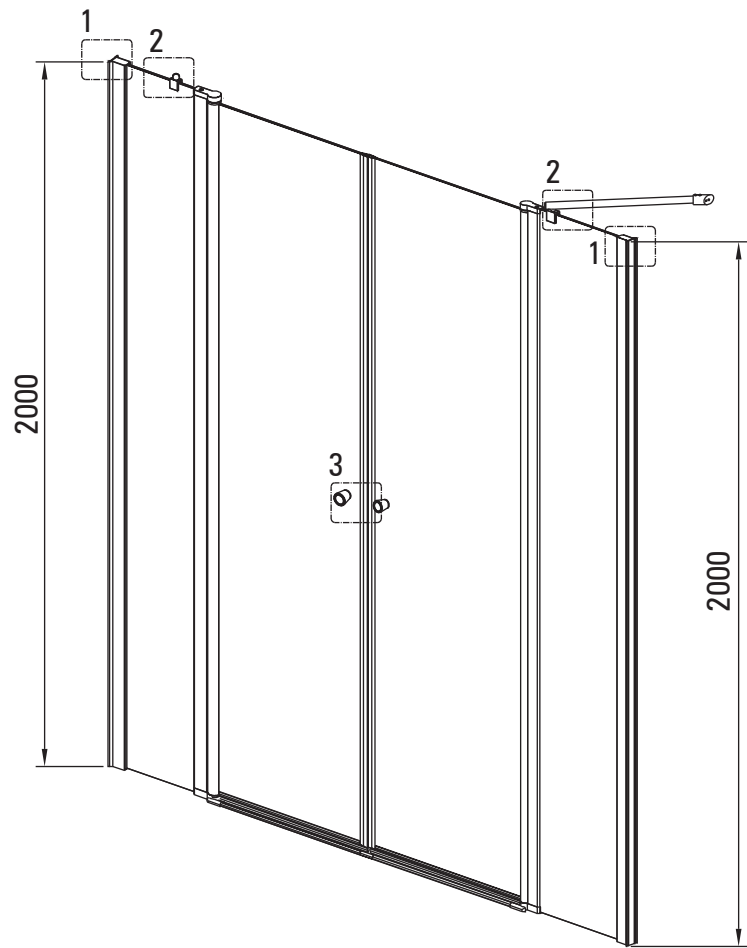
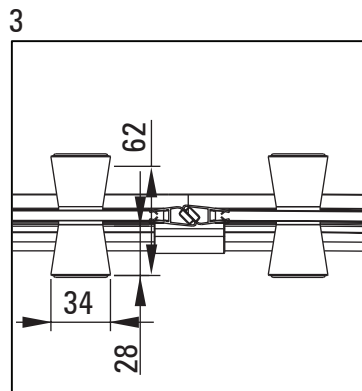
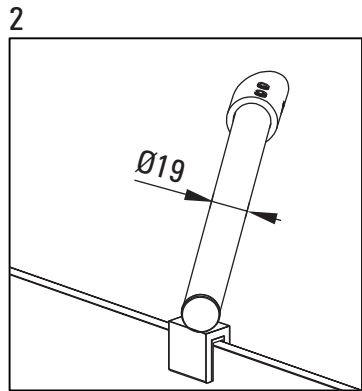
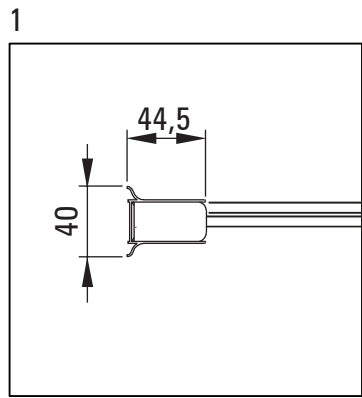

Model	Size [mm]	A [mm]	B [mm]
KTSUX42P	(A+B)x2000	765-785	765-785
KTSUX41P	(A+B)x2000	865-885	865-885
KTSUX43P	(A+B)x2000	965-985	965-985
KTSUX44P	(A+B)x2000	1065-1085	1065-1085
KTSUX45P	(A+B)x2000	1165-1185	1165-1185

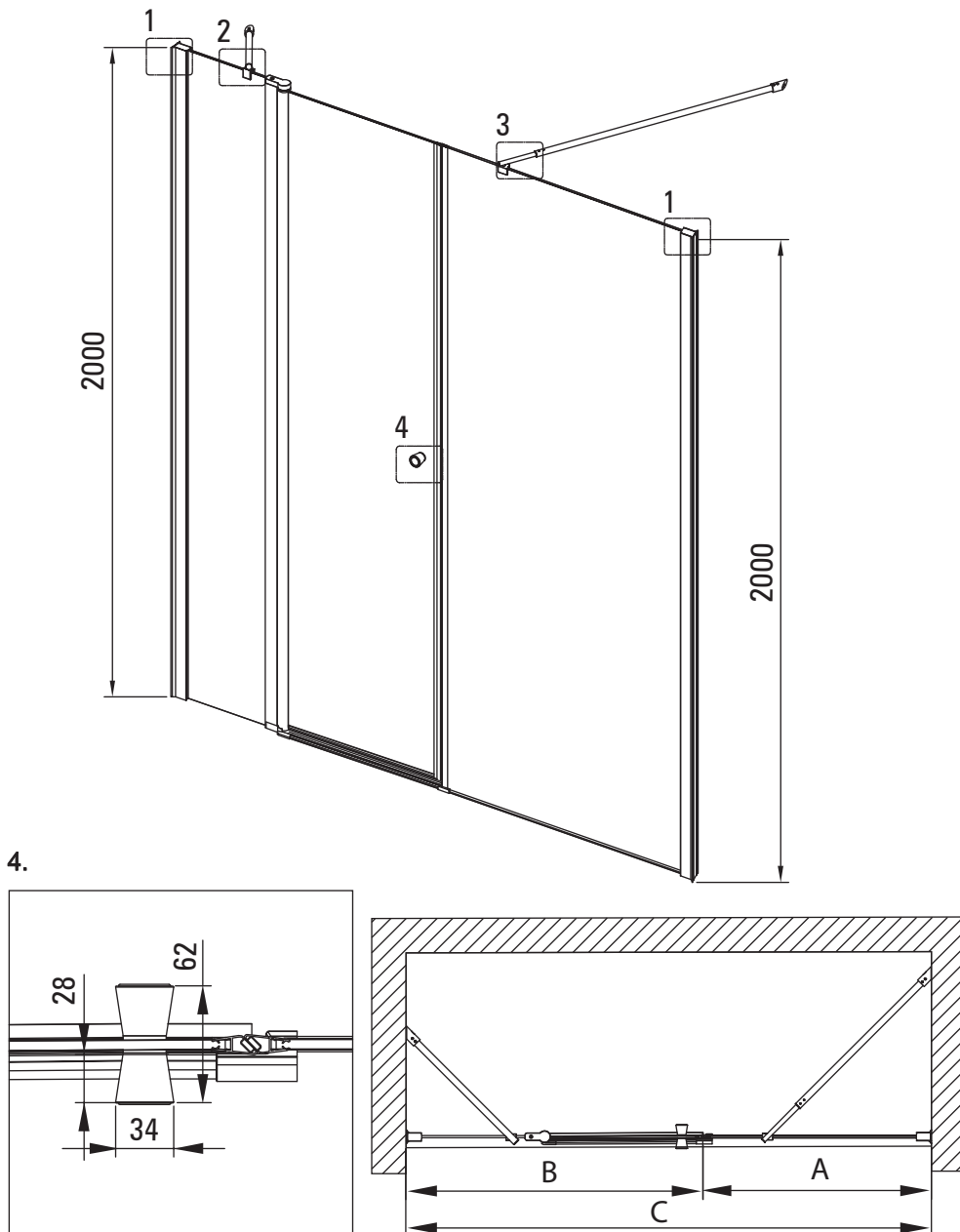
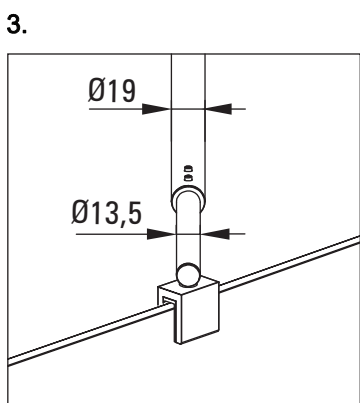
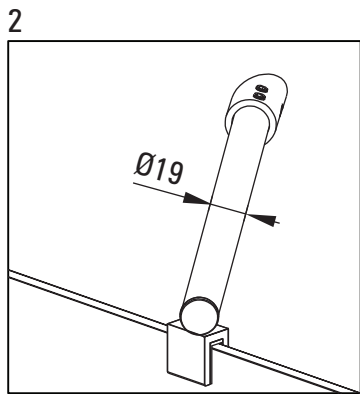
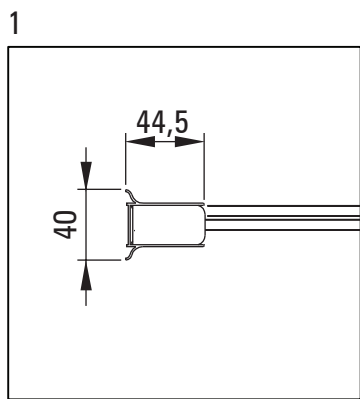

A [mm] + B [mm] = C [mm]		Model Size				
Model	Size	KTSUX42P B= 765-785	KTSUX41P B= 865-885	KTSUX43P B= 965-985	KTSUX44P B= 1065-1085	KTSUX45P B= 1165-1185
KTS_X83P	A= 265-285	C= 1030-1070	C= 1130-1170	C= 1230-1270	C= 1330-1370	C= 1430-1470
KTS_X84P	A= 365-385	C= 1130-1170	C= 1230-1270	C= 1330-1370	C= 1430-1470	C= 1530-1570
KTS_X85P	A= 465-485	C= 1230-1270	C= 1330-1370	C= 1430-1470	C= 1530-1570	C= 1630-1670
KTS_X86P	A= 565-585	C= 1330-1370	C= 1430-1470	C= 1530-1570	C= 1630-1670	C= 1730-1770
KTS_X37P	A= 665-685	C= 1430-1470	C= 1530-1570	C= 1630-1670	C= 1730-1770	C= 1830-1870
KTS_X38P	A= 765-785	C= 1530-1570	C= 1630-1670	C= 1730-1770	C= 1830-1870	C= 1930-1970
KTS_X39P	A= 865-885	C= 1630-1670	C= 1730-1770	C= 1830-1870	C= 1930-1970	C= 2030-2070
KTS_X30P	A= 965-985	C= 1730-1770	C= 1830-1870	C= 1930-1970	C= 2030-2070	C= 2130-2170
KTS_X31P	A= 1065-1085	C= 1830-1870	C= 1930-1970	C= 2030-2070	C= 2130-2170	C= 2230-2270
KTS_X32P	A= 1165-1185	C= 1930-1970	C= 2030-2070	C= 2130-2170	C= 2230-2270	C= 2330-2370
KTS_X34P	A= 1365-1365	C= 2130-2170	C= 2230-2270	C= 2330-2370	C= 2430-2470	C= 2530-2570